



2021 PARTS CATALOG

EFFECTIVE JULY 1, 2021

PRICING SUBJECT TO CHANGE WITHOUT NOTICE

KEN-WAY CORPORATION

Sparta, Wisconsin

MANUFACTURERS OF KEN-WAY DRAIN CLEANING EQUIPMENT

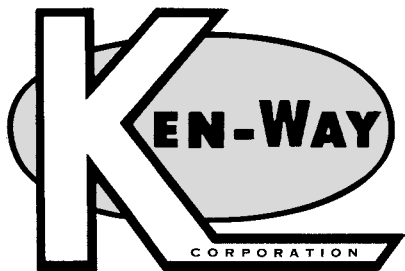

KEN-WAY CORPORATION

Box 172 • 930 Roberts Road
Sparta, Wisconsin 54656

Phone: Toll Free 1-800-533-0551

FAX: (608) 269-8129

E-Mail: info@ken-way.com

Website: www.ken-way.com

Parts Catalog 2021 *Effective*
July 1st, 2021

Equipment & Parts

	Page No.
Electric Sewer & Drain Cleaners	
Ken-Way Jr. Electric Drain Cleaner	2
Ken-Way '400' Sewer Rodder	3
Premium Music Wire Cables	
A. 1/4", 5/16", 3/8", 13/32", 1/2"	4
B. Jr. Scraping Blades	
C. 3/8", 13/32" Repair Heads	
Couplings	5
Sewer Cables	
A. 3/4" Sewer Cables	6
B. 11/16" Sewer Cables	
C. 5/8" Sewer Cables	
Ken-Way Cable Couplings	
A. Rev-Lok Locking Couplings & 3/8" SAE Thread Non-Lock	7
Accessory Tools for Model HD-53B, '300' & '400'	
Flexible Cable Leaders and Retriever Tools	8
Blade Holders & Blades	
A. For ALL Ken-Way Machines & other manufacturers.	9
Closet Augers	10
Hand Spinners	11

Visa, Mastercard, Discover, American Express Accepted

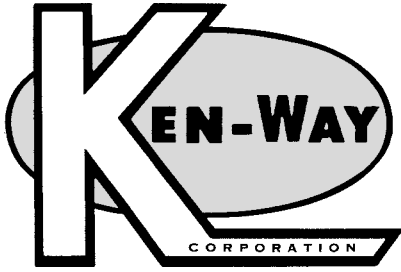

KEN-WAY JR.

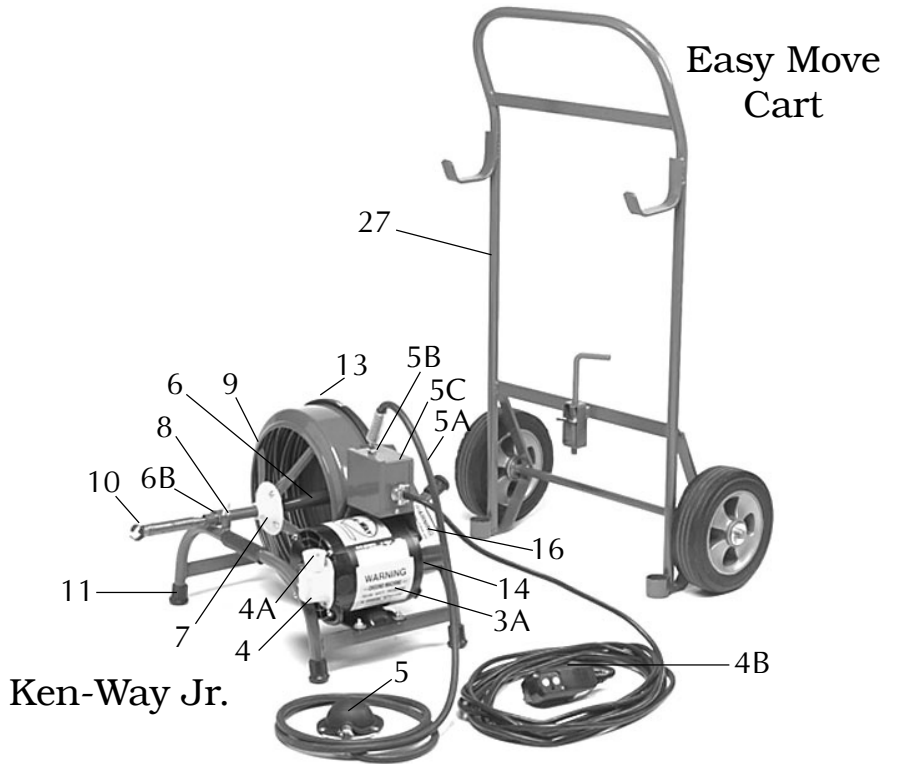

PARTS LIST FOR KEN-WAY JR.

Part Name	Item #	Price
1. Jr. Regular Drum Only	J001	\$166.45
2. Jr. Large Drum Only	J002	\$170.00
2B. Jr. Little Drum ONLY	J003	\$178.95
3A. Jr. Motor 1/4 H.P. Reversible Complete w/25' Cord & GFCI (All Machines prior June 13, 1984)	J004	\$330.70
3B. Jr. Motor 1/4 H.P. Complete wire for Air F.S. w/25' Cord & GFCI (All Machines since June 14, 1984)	J005	\$323.85
4. Jr. Motor Reversing Switch Complete w/Terminal Box & Wiring	J006	\$32.75
4A. Jr. Motor Reversing Switch Only	J007	\$28.70
4B. Electric Power Cord - 25' w/ GFCI	J012	\$67.85
5A. Jr. Air Foot-Pedal w/Pedal & Hose (All Machines June 14, 1984 and on.)	J008	\$32.75
5B. Air Switch Internal	J010	\$20.70
5C. Air Switch Junction Box Only	J011	\$14.65
5. Air Pedal Only	J013	\$17.55
6. Jr. Crank-Arm Only w/Snap Washers (For Regular & Large Jr. Drums)	J014	\$38.20
6A. Jr. Crank-Arm Assembly Complete w/2 Bearings (For Regular & Large Jr. Drums)	J015	\$57.30
6B. Jr. Crank-Arm Bearings Only	J016	\$12.75
7. Jr. Name Plate Only	J019	\$9.30
8. Jr. Frame Wing Nuts Each	J020	\$1.05
9. Jr. Drum Cable Anchors w/Nut & Bolt	J021	\$2.65
10. Jr. Blade Holder Plugs for 3/8" Cable	J022	\$8.65
11. Jr. Rubber Frame Tips	J023	\$1.25
12. Jr. Blade Holder Plugs for 1/2" Cable	J024	\$11.70
13. Jr. V-Belt	J025	\$12.80
14. Jr. Motor Pulley	J026	\$10.60
15. Bearing Retaining Snap Rings for Jr. Drums	J027	\$1.15
16. Jr. Belt Guard	J028	\$15.55
17. Jr. Complete Frame Only	J029	\$170.10
18. Reversing Switch Box	J030	\$3.00
19. Switch Guard	J033	\$1.00
20. Ugly Gloves	J240	\$9.10
21. Jr. Air Hose Only	J032	\$9.95
22. Jr. Crank-Arm Only (For Jr. Little Drums)	J052	\$57.30
23. Jr. Crank-Arm Assembly Complete w/ Bearings (For Jr. Little Drum)	J089	\$54.40
24. Jr. Drop Head Plug For 3/8" & 13/32" (To Take Drop Heads)	J071	\$10.85
25. Air Hose Clamps	J034	\$1.00
26. Snake Oil Quart	J328	\$9.70
27. Jr. Easy Move Cart (Frame Models Since April 15, 2005)	J385	\$164.85
28. Jr. Easy Move Cart (Frame Models Before April 15, 2005)	J386	\$175.25

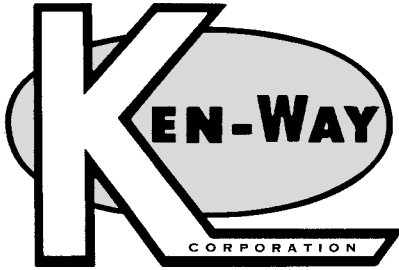

'400' SEWER RODDER

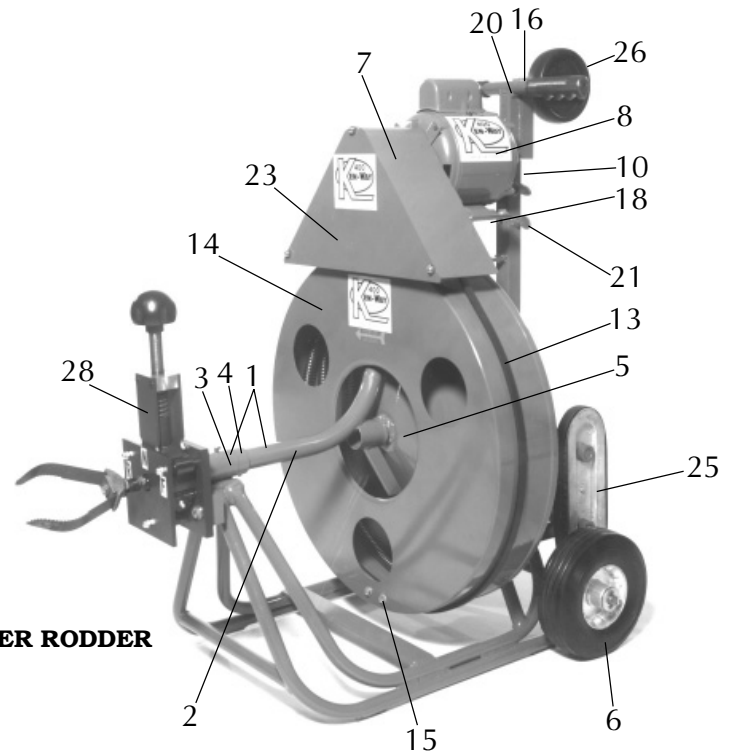

'400' SEWER RODDER

PARTS LIST FOR KEN-WAY '400'

Part Name	Item #	Price
1. Ken-Way Crank-Arm Assembly Complete	F008	\$116.85
2. Ken-Way Crank-Arm Only	F009	\$97.20
3. Crank-Bearing & Housing Only	F010	\$25.35
4. Crank-Arm Collars for above (set of two)	F011	\$13.15
5. '400' Drum Bearing (2 Piece)	F012	\$23.50
6. Rubber Wheels 8" Each	F013	\$24.25
7. 3-Speed Motor Pulley	F014	\$13.90
8. Motor 1/2 H.P. Capacitor W. Rev. Switch, 25' Power Cord & GFCI & Pulley	F015	\$599.80
9. Air Foot Pedal w/8' Air Hose & Quick Disconnect Coupling	F016	\$44.05
9B. Air Switch Internal w/ Quick Disconnect	F018	\$23.10
9C. Air Switch Junction Box Only	F019	\$15.05
9D. Air Pedal Only	F021	\$17.50
9E. Female Quick Disconnect Coupling For Air Switch	F022	\$11.35
9F. Male Quick Disconnect Barb For Air Switch	F023	\$5.70
10. Motor Reversing Switch Complete w/Terminal Box	F024	\$32.80
11. Motor Reversing Switch Unit Only	F026	\$22.80
13. V-Belt Only	F027	\$19.70
14. '400' Drum Only (Less Cable)	F004	\$535.05
15. Drum Cable Anchor Only	F029	\$8.30
16. Truck Loader	F031	\$20.25
17. Tool Box Only	F211	\$35.00
18. Motor Support Assembly	F032	\$27.75
19. Rubber Handle Grips	F005	\$3.15
20. Handle Rod Assembly w/Grips	F030	\$23.65
21. Thumb Screws for Motor Assembly & Dolly Handle	F017	\$1.60
22. Tool Box Complete w/Air Foot-Switch, Flex. Leader, Retriever, 6-Blades, Couplings	F036	\$263.35
23. '400' Belt Guard	F037	\$42.10
24. Drain Plug for '400' Drum	F038	\$0.60
25. Step Climbers Each	F039	\$49.05
26. 5" Wheel for Truck Loader	F040	\$9.90
27. Cable Drive Mounting Plate	F042	\$37.25
28. Ken-Way Cable Drive (Automatic Power Feed Unit) Model # 200	F043	\$492.45
29. Heavy Duty Work Gloves	F044	\$53.70
30. Air Hose w/ Quick Disconnect and Clamps	F041	\$22.35
31. 25' Electric Power Cord w/ GFCI	F052	\$67.85
32. Air Hose Clamps	F053	\$0.90
33. '400' Frame Only	F054	\$605.25
34. Snake Oil Quart	F077	\$9.95
35. Cable Drive Bearing	D004	\$9.90

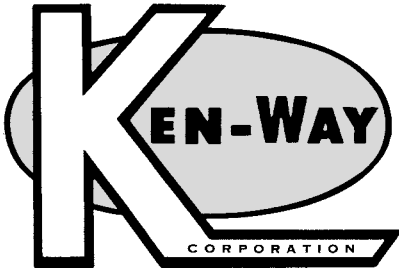

MUSIC WIRE CABLES

Premium Grade Wire - Heat Treated For Stress Relief
"THE VERY BEST ALWAYS"
Left Hand Wound

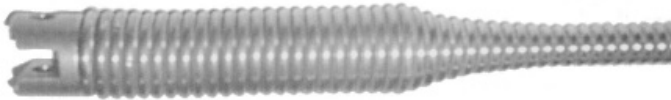

#8 Plug Attach Blades, Extractor Hook or Drop Head



#6 Attach Blades or Extractor Hook

NO CORE CABLES W/ BLADE HOLDERS

(5/16" & 3/8" Can Be Furnished w/ Drop Head Plug - Please Specify)

Part Name	Item #	Price
5/16" x 25' w/ Blade Holder #8	J197	\$49.85
5/16" x 50' w/ Blade Holder #8	J060	\$82.65
5/16" x 75' w/ Blade Holder #8	J139	\$117.95
3/8" x 50' w/ Blade Holder #6 or #8	J061	\$94.30
3/8" x 75' w/ Blade Holder #6	J062	\$127.70
1/2" x 50' w/ Blade Holder #6	J063	\$121.15
1/2" x 75' w/ Blade Holder #6	J064	\$146.15
1/2" x 100' w/ Blade Holder #6	J285	\$208.95

INNER CORE CABLES W/ BLADE HOLDERS

Part Name	Item #	Price
5/16" x 50' Inner Core w/ Blade Holder #8	J161	\$89.20
5/16" x 75' Inner Core w/ Blade Holder #8	J162	\$133.55
3/8" x 50' Inner Core w/ Blade Holder #6 or #8...	J306	\$110.15
3/8" x 75' Inner Core w/ Blade Holder #6 or #8...	J304	\$149.75
13/32" x 50' Inner Core w/ Blade Holder #6 or #8J065		\$127.70
13/32" x 75' Inner Core w/ Blade Holder #6 or #8J066		\$162.00
1/2" x 50' Inner Core w/ Blade Holder #6	J067	\$159.15
1/2" x 75' Inner Core w/ Blade Holder #6	J068	\$217.40
1/2" x 100' Inner Core w/ Blade Holder #6	J227	\$265.50



Part Name	Item #	Price
Drop Head for 3/8" & 13/32" Cable	J069	\$39.65
Drop Head for 5/16" Cable	J070	\$38.80
Drop Head Cable Plug for 3/8" & 13/32"	J071	\$10.85
Punch for Drop Head Pins	J140	\$7.30
Expansion Pin for Drop Head	J141	\$0.40

(Cables Need Spec. Plug for Drop Heads)
 (See #24 Jr. Parts)

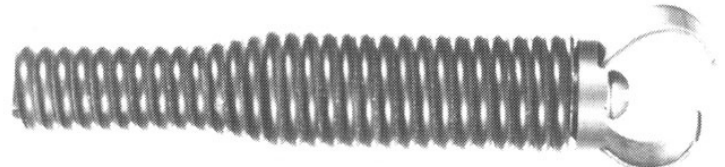

Part Name	Item #	Price
Drop Head Cable Plug for 3/8"	J072	\$10.85
Extractor Hook for 3/8" & 13/32" w/ Blade Holder	J074	\$7.90

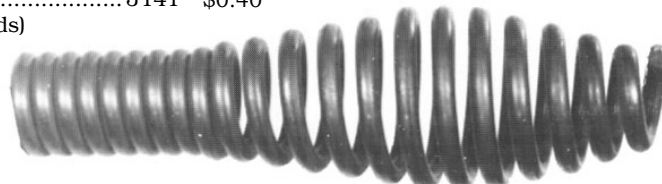

CABLES W/ BULB-ENDS

Part Name	Item #	Price
3/8" x 25' w/ Bulb-End	J088	\$51.50
3/8" x 50' w/ Bulb-End	J076	\$92.60
3/8" x 75' w/ Bulb-End	J075	\$125.65
5/16" x 25' w/ Bulb-End	J078	\$49.95
5/16" x 50' w/ Bulb-End	J077	\$72.95
5/16" x 75' w/ Bulb-End	J142	\$109.10

Part Name	Item #	Price
1/4" x 15' w/ Bulb-End	J170	\$22.90
1/4" x 25' w/ Bulb-End	J080	\$32.65
1/4" x 50' w/ Bulb-End	J143	\$49.50

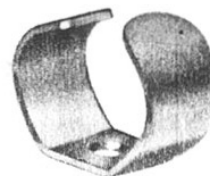

SCRAPING BLADES FOR 5/16", 3/8", 13/32" & 1/2"

Part Name	Item #	Price
1" Jr. Blade for 3/8" Cable	J081	\$2.70
1-1/4" Jr. Blade for 3/8" Cable	J082	\$2.80
1-1/2" Blade for 3/8" Cable	J083	\$2.90
2" Blade for 3/8" Cable	J195	\$3.00
3/4" Blade for 5/16" Cable	J144	\$2.65
1" Blade for 5/16" Cable	J145	\$2.75

Part Name	Item #	Price
1-1/2" Blade for 1/2" Cable	J171	\$3.85
1-3/4" Blade for 1/2" Cable	J172	\$4.05
2" Blade for 1/2" Cable	J084	\$4.15
3" Blade for 1/2" Cable	J085	\$4.70
Blade Retaining Screw & Washer	J086	\$0.60
Blade Retaining Screw for Drop Head Plugs	J087	\$0.65

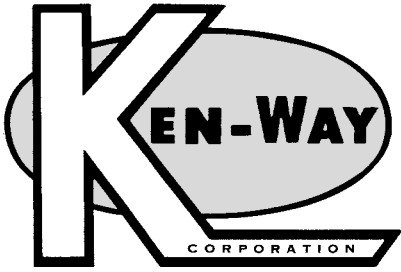

COUPLINGS

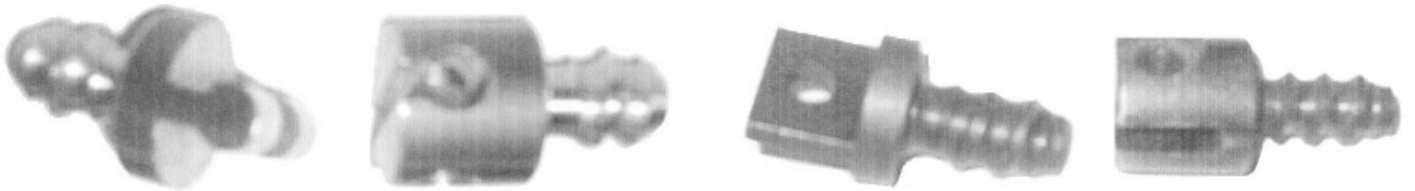

PIN LOCK

(Pin Lock for 5/8", 11/16" and 3/4" Cable)

Part Name	Item #	Price
Pin Lock Male	F401	\$7.10
Pin Lock Female	F402	\$7.10

SLOTTED

(Slotted for 5/8", 3/4" and 11/16" Cable)

Part Name	Item #	Price
Slotted Male	F404	\$7.10
Slotted Female	F405	\$7.10



(For 5/8", 11/16" and 3/4" Cable)

Part Name	Item #	Price
Threaded Male	F412	\$7.10
Slip Joint Female	F212	\$8.40

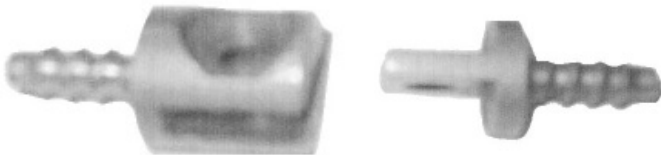

(3/8", 13/32" and 1/2" Cable)

Part Name	Item #	Price
Slotted Female	J404	\$7.10
Slotted Male	J405	\$7.10

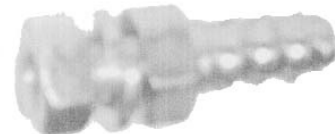

(For 3/8", 13/32" and 1/2" Cable)

Part Name	Item #	Price
Threaded Male	J407	\$5.55



MUSIC WIRE SEWER CABLES



Heat Treated - Finest Quality Music Wire, Greater Strength - With More Flexibility -
Easily Spliced - More For Your Money. Guaranteed. Left Hand Wound.

PRICES WITH CONNECTIONS

3/4" CABLES W/COUPLINGS

NO CORE SEWER CABLES

Part Name	Item #	Price
3/4" x 10' Anchor Cable (*400' Machine Comes w/ 10' Anchor)	F047	\$30.25
3/4" x 25' Sewer Cable w/ Couplings	F046	\$75.10
3/4" x 50' Sewer Cable w/ Couplings	F048	\$150.10
3/4" x 90' Sewer Cable w/ Couplings	F049	\$267.40
3/4" x 100' Sewer Cable w/ Couplings	F050	\$297.10
3/4" x 110' Sewer Cable w/ Couplings	F173	\$326.90
3/4" x 130' Sewer Cable w/ Couplings	F174	\$386.30

INNER CORE SEWER CABLES

Part Name	Item #	Price
3/4" x 10' w/ Inner Core & Couplings	F175	\$42.50
3/4" x 25' w/ Inner Core & Couplings	F176	\$101.25
3/4" x 50' w/ Inner Core & Couplings	F177	\$191.40
3/4" x 90' w/ Inner Core & Couplings	F108	\$307.15
3/4" x 100' w/ Inner Core & Couplings	F179	\$343.90
3/4" x 110' w/ Inner Core & Couplings	F180	\$410.20
3/4" x 130' w/ Inner Core & Couplings	F166	\$445.15

(With Aircraft Wire — or — Plastic)

11/16" CABLES W/ COUPLINGS

NO CORE

Part Name	Item #	Price
11/16" x 50'	F045	\$142.55
11/16" x 100'	F205	\$275.80
11/16" x 120'	F206	\$314.40
11/16" x 150'	F202	\$374.80

INNER CORE

Part Name	Item #	Price
11/16" x 50'	F221	\$179.80
11/16" x 100'	F317	\$322.75
11/16" x 120'	F320	\$352.80
11/16" x 150'	F207	\$443.60

(With Aircraft Wire — or — Plastic)

5/8" CABLES W/ COUPLINGS

NO CORE CABLES

Part Name	Item #	Price
5/8" x 5' Anchor Cable	F083	\$27.75
5/8" x 50' Cable	F079	\$132.85
5/8" x 75' Cable	F081	\$196.10
5/8" x 100' Cable	F082	\$260.95

INNER CORE CABLES

Part Name	Item #	Price
5/8" x 25' w/ Inner Core	F074	\$89.00
5/8" x 50' w/ Inner Core	F080	\$161.35
5/8" x 75' w/ Inner Core	F084	\$222.55
5/8" x 100' w/ Inner Core	F183	\$285.75

(With Aircraft Wire — or — Plastic)

PLEASE NOTE: If you wish couplings installed in cables, please specify TYPE and MALE or FEMALES.
We can furnish with most manufacturers' types.

STRAIGHT CABLES W/ NO FLARES

Part Name	Item #	Price
3/8" x 65' Cable w/ Threaded Male	CC062	\$99.00
3/8" x 90' Cable w/ Threaded Male	CC057	\$137.80
1/2" x 50' w/ Threaded Male	CC173	\$117.20
1/2" x 75' w/ Threaded Male	CC172	\$141.70

PLEASE NOTE: Special sizes and lengths of cables are available.
We make our own cable and can furnish additional sizes and lengths. Give us a call - (800) 533-0551.

Part Name	Item #	Price
CABLE UNCOUPLING STAND	S048	\$19.65

Use: Supports and holds cable in place when uncoupling



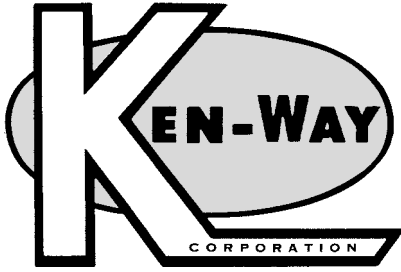

3/4" Sewer Cable Couplings

KEN-WAY Rev-Lok Locking Couplings & Easy-Start Non-Locking Couplings

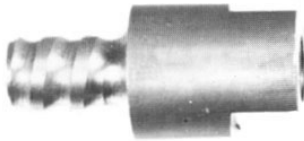

Non-lock Female Coupling
3/8" S.A.E. Thread
Item # F061 - \$8.60 Each



Non-lock Male Coupling
3/8" S.A.E. Thread
Item # F062 - \$7.60 Each

Easy-Start Non-Locking Cable Couplings

The Ken-Way Non-lock Couplings of Round Stock with wide flat surface for positive Blade Holder attachment. Makes for easy coupling installation on the job. Developed over the past thirty (30) years, you can depend on them being the very best.

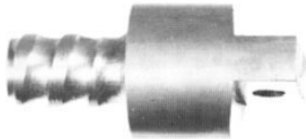

Rev-Lok Locking Male Coupling
Item # F063 - \$7.95 Each



Coupling Screws Item
F065 - \$.45 Each

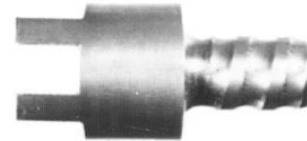

Rev-Lok Locking Female Coupling
Threaded to take 3/8"S.A.E.
Blade Holder Bolt
Item # F064 - \$9.10 Each

Rev-Lok Locking Cable Couplings

The Ken-Way Rev-Lok Locking Cable Couplings are designed for use on all Reversing Type 3/4" Sewer Cables. Slip Male and Female Coupling together, insert threaded bolt and tighten with a screwdriver. Coupling guaranteed to hold even when running high speed in reverse for extended periods. When uncoupling, all you need is a screwdriver, no punch or pins needed, gives longer trouble free service.



Cable Splicer for 3/4" Cable
Item # F066 - \$7.95 Each

Cable Splicer

For splicing all 3/4" sewer cable. Can be done quickly on the job to repair a broken or kinked piece of cable. Once cable is spliced it is meant to last and operate through the normal life of the sewer cable.

When ordering '400' or '300' Sewer Rodders, or all used machines, please specify which type of coupling you desire.

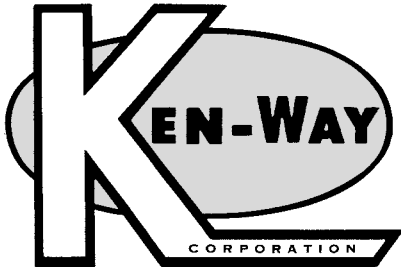

ACCESSORY TOOLS

FOR 3/4" AND 5/8" CABLE
MODEL '400', '300', OHD, HD-53 & HD-53B SEWER MACHINES
(IF OTHER TYPE COUPLINGS PLEASE SPECIFY)



NO TENSION FLEXIBLE CABLE LEADER
Item # F067 - 3/4" \$34.80

NO TENSION FLEXIBLE CABLE LEADER
Item # F184 - 5/8" \$33.40

(Shown With Rev-Lok Locking Coupling)

Flexible Cable Leader - Gives Extra Flexibility for rodding through
"P" Traps, Etc. Please specify either 3/8" S.A.E. Thread, or Rev-Locking Coupling

RETRIEVER TOOL

Will retrieve roots, rags, etc. from lateral and mainline sewers.
For use only with 3/4" Cable.
Please specify Coupling type.

(Shown With Rev-Lok Locking Coupling)

Item # F068 - \$25.35

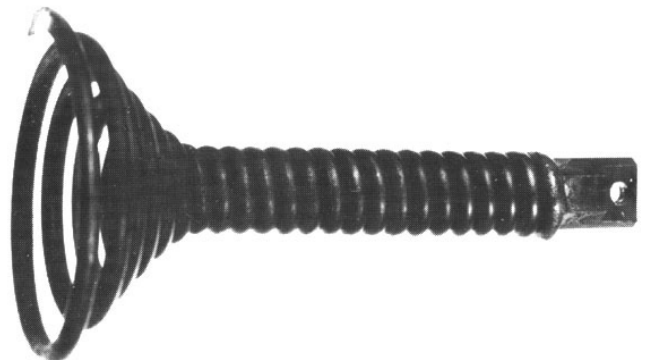

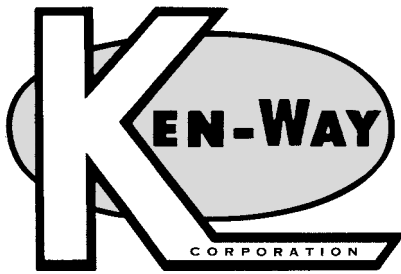

BLADE HOLDERS AND BLADES

FOR MODELS '400', '300' OHD, HD-53 & 53B
Sewer Machines - 3/4" Cable

STANDARD 'U' TYPE BLADES

Part Name	Item #	Price
2" U Blades	F055	\$6.55
3" U Blades	F056	\$6.95
4" U Blades	F057	\$7.55
6" U Blades	F058	\$9.55

Cutting Blades

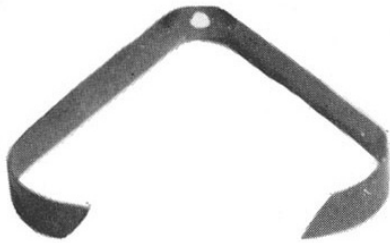

P-TRAP BLADES

Part Name	Item #	Price
2" P-Trap Blade	F069	\$4.95
2 1/2" P-Trap Blade	F070	\$5.15
3" P-Trap Blade	F071	\$5.65
3 1/2" P-Trap Blade	F072	\$6.05

3-PRONG BLADES

Part Name	Item #	Price
2" 3 Prong Blades (Each)	MC115	\$3.65
3" 3 Prong Blades (Each)	MC109	\$4.35
4" 3 Prong Blades (Each)	MC131	\$5.20
6" 3 Prong Blades (Each)	MC135	\$5.85

SPEAR BLADES
Item # F307 - \$17.15



GREASE BLADES

Part Name	Item #	Price
2" Grease Blade	F345	\$9.60
3" Grease Blade	F316	\$9.85
4" Grease Blade	F328	\$10.25

BORING TOOL
Item # F332 - \$19.25

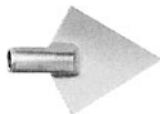

BLADE HOLDERS, NON-LOCK 3/8" S.A.E.
Item # F059 - \$12.75
(FOR 5/8", 3/4" & 11/16" CABLE)

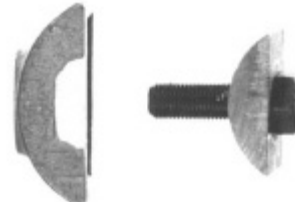

3-BLADE HOLDER
Item # F356 - \$23.75
Uses: Holds 2" to 6" Tri-Blade Cutters



BLADE HOLDERS (SMALL)
Item # F210 - \$8.10
(FOR P-TRAP BLADES) 5/8", 3/4" & 11/16"



SAW BLADES
Item # F353 - \$24.25
Line Use 4" - 6"



BLADE HOLDER, LOCK-ON 3/8" S.A.E.
Item # F060 - \$11.25
(FOR 5/8", 3/4" & 11/16" CABLE)



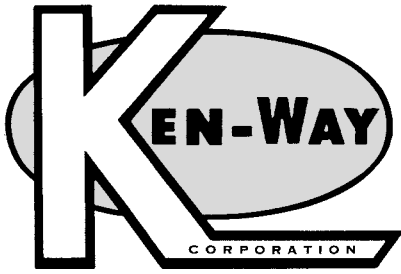

CLOSET AUGERS

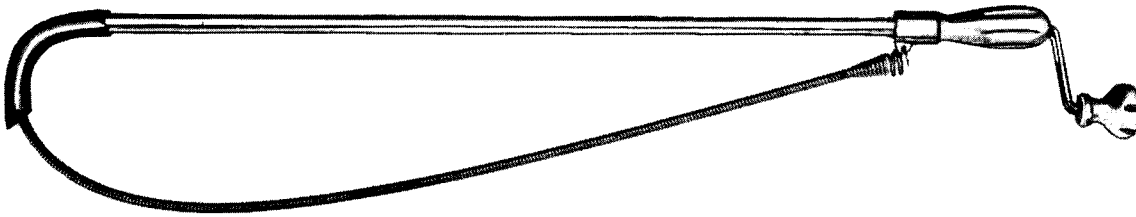

HEAVY DUTY CLOSET AUGER

3/4" Steel Tube cadmium plated to prevent rust. Cast aluminum grip handle.

Extra heavy steel crank with cast aluminum turning knob. Rubber bowl guard.

One piece heat-tempered music wire spring with open hook end.

Wire will not pull out top of tube.

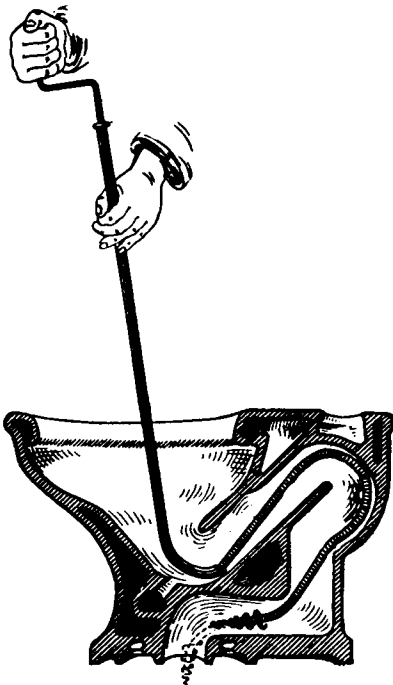

HEAVY DUTY CLOSET AUGER. Flexible Coil made of a special prepared SWEDISH SPRING STEEL MUSIC WIRE. No. 12 gauge, 1/2" size, with removable corkscrew and cone wire. A very flexible and most durable spring made. Assembled with steelhandle and heavy steel tube, cadmium plated, non-rusting. Perfect construction; lasts indefinitely.

Part Name	Item #	Price
Heavy Duty Closet Auger 6' w/ Drop-Head	J207	\$70.25
Refill Wire 6' w/ Drop-Head	J330	\$45.85
Heavy Duty Closet Auger 6' w/ Bulb-End	J208	\$62.45
Refill Wire 6' w/ Bulb-End	J315	\$37.95

We Hope You Will File This Catalog,
And Use It To Full Advantage
On Future Orders.

PHONE

TOLL
FREE

1-800-533-0551
(608) 269-3752

Fax (608) 269-8129

For Your Convenience
And To Avoid Delays,
Use The Enclosed Order Blank.

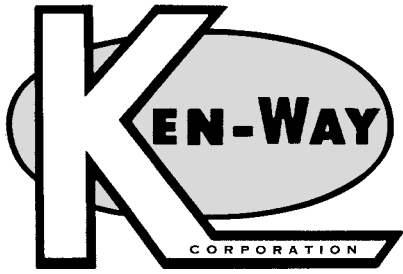

HAND SPINNER

Highest Quality - Hand Tighten Chuck - No Trap or Cross Bar Removal -
Light Weight - Easy to Use, 1" to 1-1/2" Drain Lines.

Part Name	Item #	Price
Ken-Way Hand Spinner - with 1/4" x 15' Open End Cable - Complete.....	J338	\$74.50
Ken-Way Hand Spinner - with 1/4" x 25' Open End Cable - Complete.....	J342	\$84.20

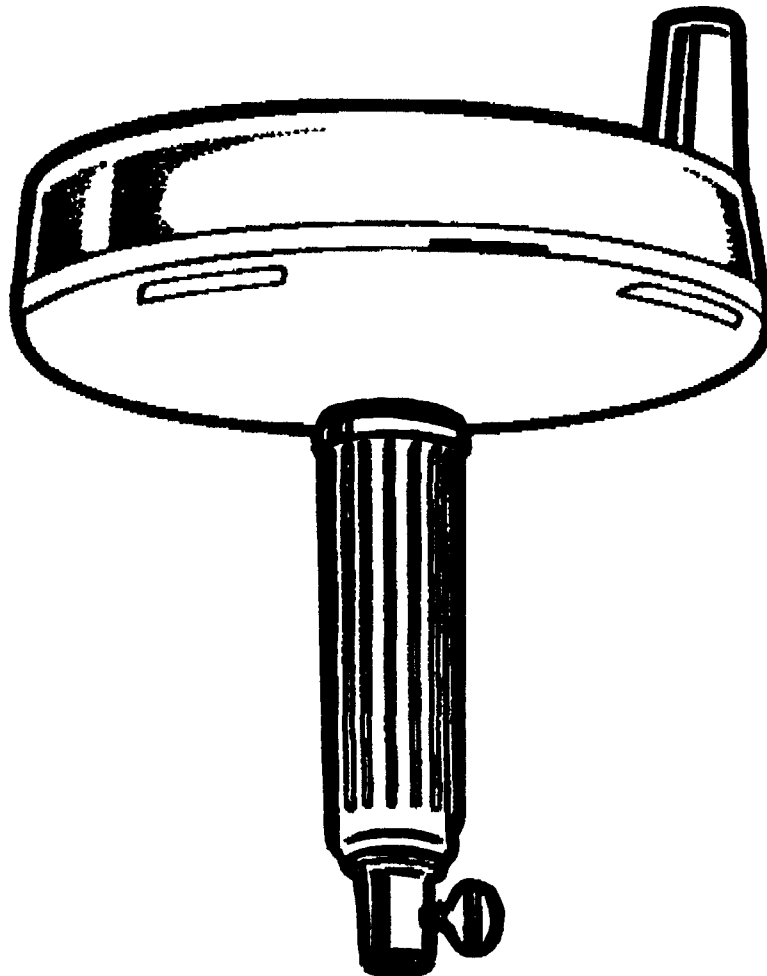

NOTES



Box 172 • 930 Roberts Road • Sparta, Wisconsin 54656-0172

Phone: Toll Free 1-800-533-0551

FAX: (608) 269-8129

E-Mail: info@ken-way.com

Website: www.ken-way.com